

VINYL SERIES 211 PICTURE WINDOWS

TEST SIZE W x H	AAMA RATING	AIR INFILTRATION	DESIGN PRESSURE	WATER RESISTANCE	U-VALUE	SHGC	VT
47.25" x 47.25"	R-PG60	≤0.30 cfm/ft ²	60 psf	9 psf	0.20-0.46	0.21-0.69	0.40-0.72



TABLE OF CONTENT

- INTRODUCTION -P1
- SECTION DETAILS -P2
- MULLION -P3
- ARCHITECTURAL SHAPES -P4-P5

FEATURES

- 3-1/4" FRAME DEPTH
- 7/8" INSULATED GLASS
- SOFT COAR LOW-E & ARGON FILLED IGU
- FUSION WELDED FRAME
- DESIGNER BEVELED PROFILE
- DOUBLE-STRENGTH GLASS
- STRONG MULTI-CHAMBER CONSTRUCTION

OPTIONAL SELECTIONS

- TRIPLE-GLAZED INSULATED GLASS UNIT
- PERFORMANCE TC™ HIGH PERFORMANCE LOW-E UPGRADE
- BETWEEN THE GLASS OR EXTERIOR APPLIED GRIDS
- ARCHITECTURAL SHAPES
- NAILING FIN ATTACHMENT
- SNAP-ON J-CHANNEL
- EXTRUDED BEIGE COLOR
- PAINTED EXTERIOR CUSTOM COLOR

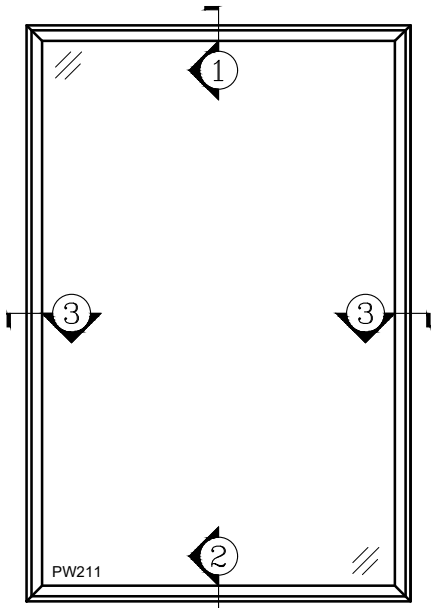

211 PICTURE WINDOW

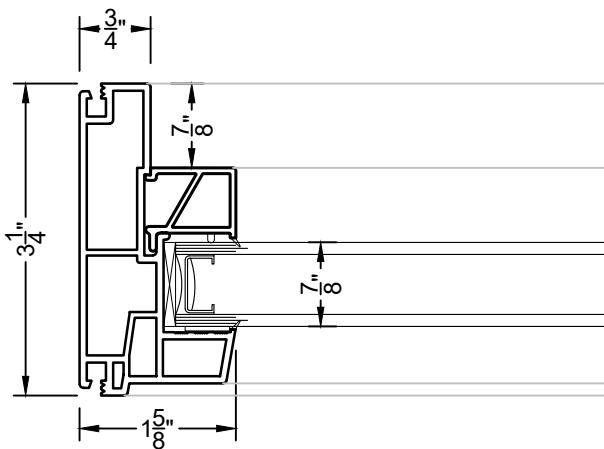
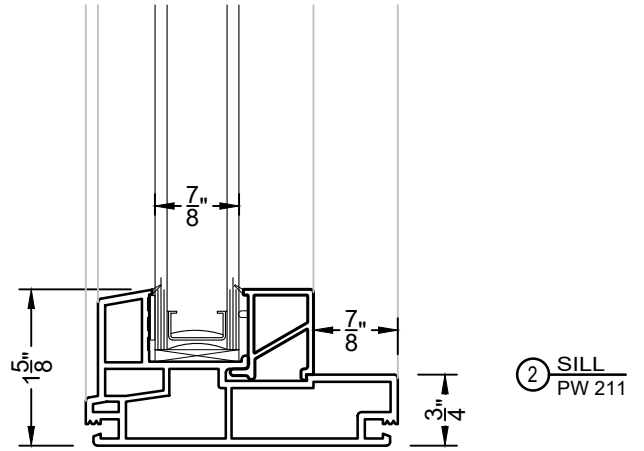
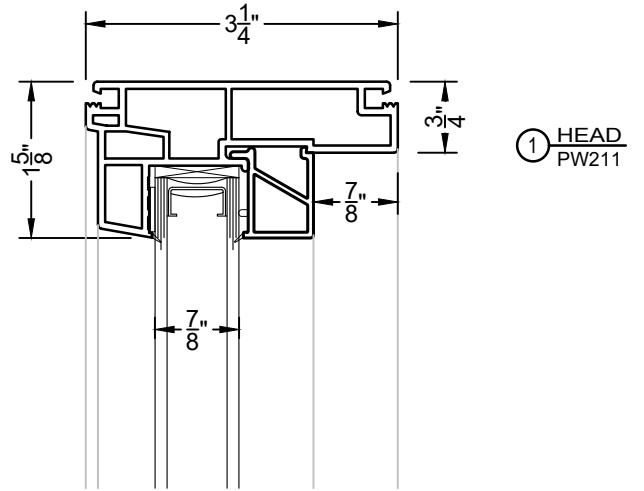

③ JAMB
PW 211

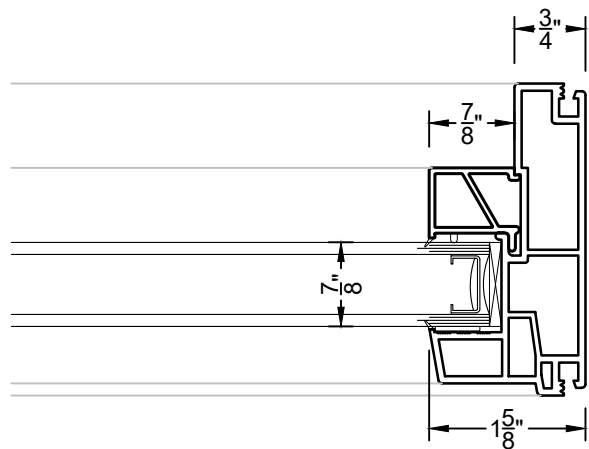

③ JAMB
PW 211

VER: 2020.08

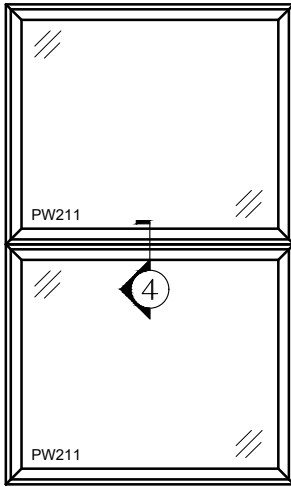

211 PICTURE WINDOW W/ 0° MULLION

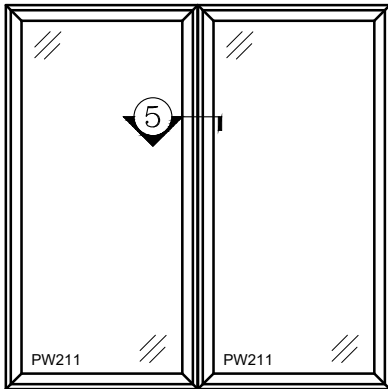

211 PICTURE WINDOW W/ 0° MULLION

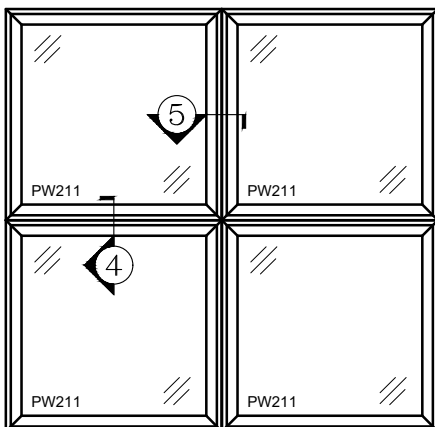

211 PICTURE WINDOW W/ 0° MULLION

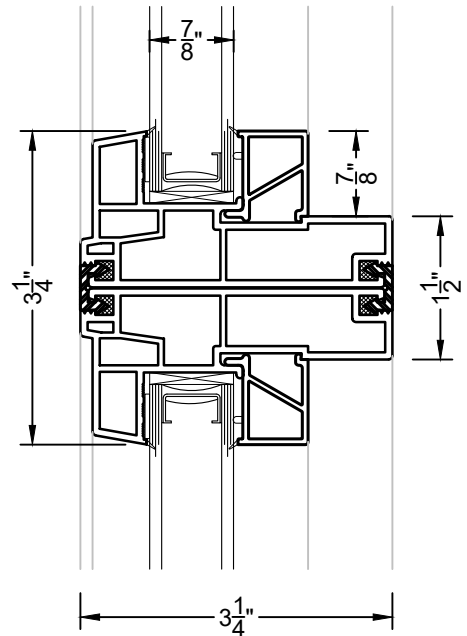

④ 0 DEGREE MULLION
 PW 211

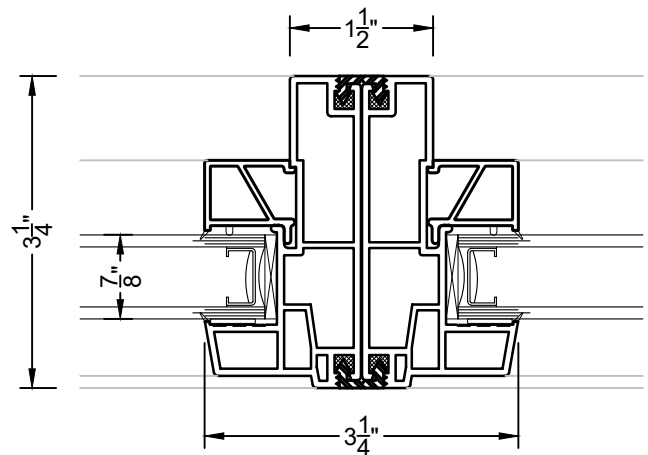

⑤ 0 DEGREE MULLION
 PW 211



CAP 280-01 ELLIPSE

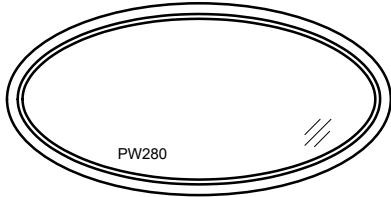

CAP 280-02 OVAL

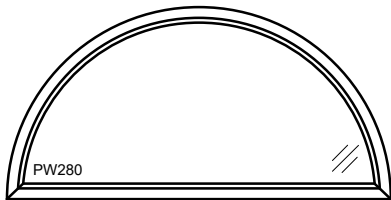

CAP 280-03 CIRCLE TOP

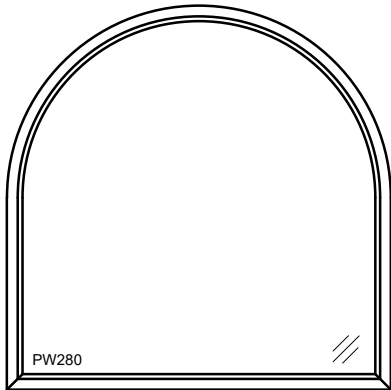

CAP 280-04 CIRCLE TOP
W/ EXTENDED LEG

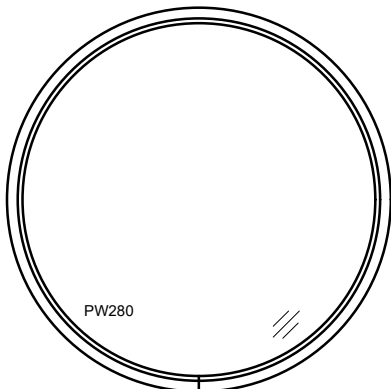

CAP 280-05 FULL CIRCLE

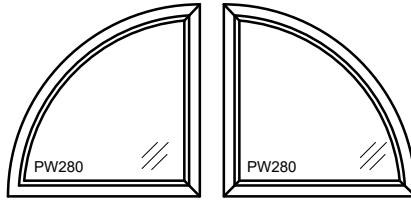

CAP 280-06 QUARTER ARCH

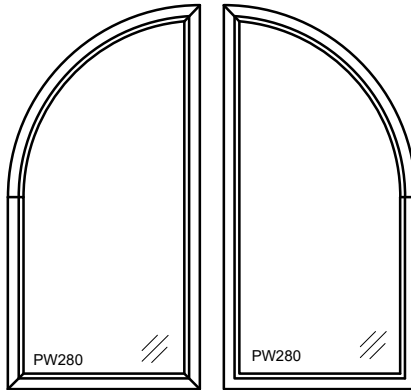

CAP 280-07 QUARTER ARCH
W/ EXTENDED LEG



CAP 280-08 EYEBROW

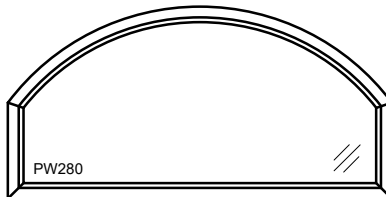

CAP 280-09 EYEBROW
W/ EXTENDED LEG

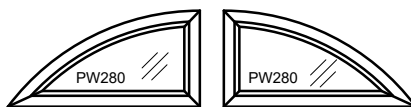

CAP 280-10 HALF EYEBROW

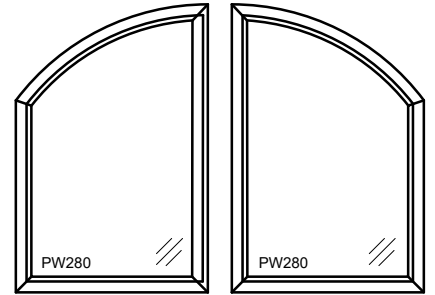

CAP 280-11 HALF EYEBROW
W/ EXTENDED LEG

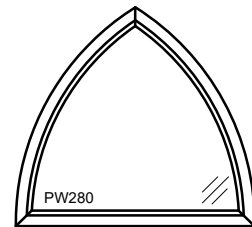

CAP 280-12 CATHEDRAL

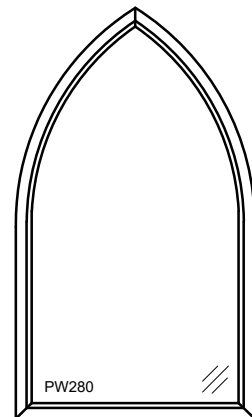

CAP 280-13 CATHEDRAL
W/ EXTENDED LEG

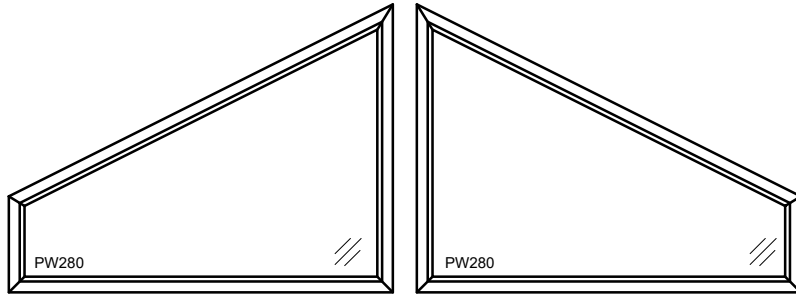

CAP 280-14 TRAPEZOID LEFT & RIGHT

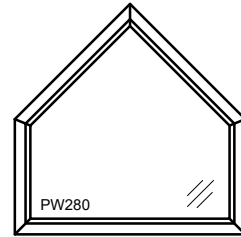

CAP 280-22 PENTAGON

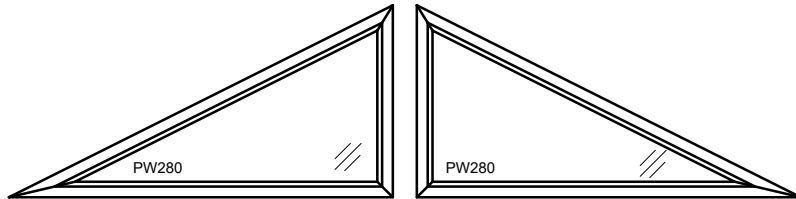

CAP 280-15 TRIANGLE LEFT & RIGHT

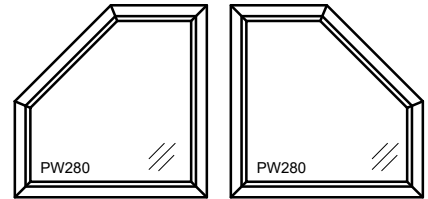

CAP 280-23 PENTAGON LEFT & RIGHT

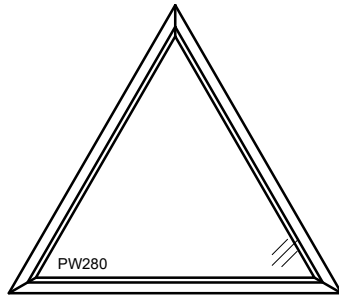

CAP 280-16 TRIANGLE EQUILATERAL

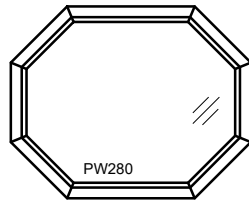

CAP 280-19 OCTAGON W/ EXTENDED LEG

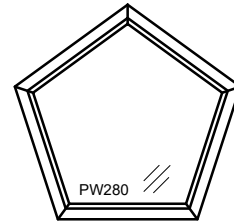

CAP 280-24 PENTAGON EQUILATERAL



CAP 280-17 TRIANGLE ISOSCELES

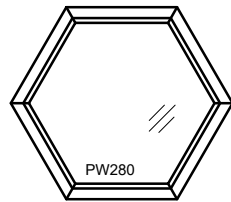

CAP 280-20 HEXAGON W/ EXTENDED LEG

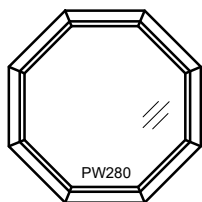

CAP 280-18 OCTAGON

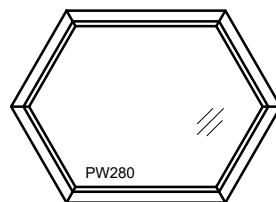

CAP 280-21 HEXAGON W/ EXTENDED LEG